

# LES SOLUTIONS INDUSTRIE

- ACCUEIL →
- SALLE DE REUNION ←
- TOILETTES →
- ESCALIER ↘
- SORTIE DE SECOURS →

**Bien  
se diriger et  
sécuriser ses  
locaux.**

**ACCUEIL**



**Votre solution pochoir  
& signalétique  
Fabriqué en France**



# J'accueille mes visiteurs

## Les adhésifs au sol

Adhésif de longue tenue avec lamination antidérapante R9 de grande qualité  
Bande de 120/7 cm

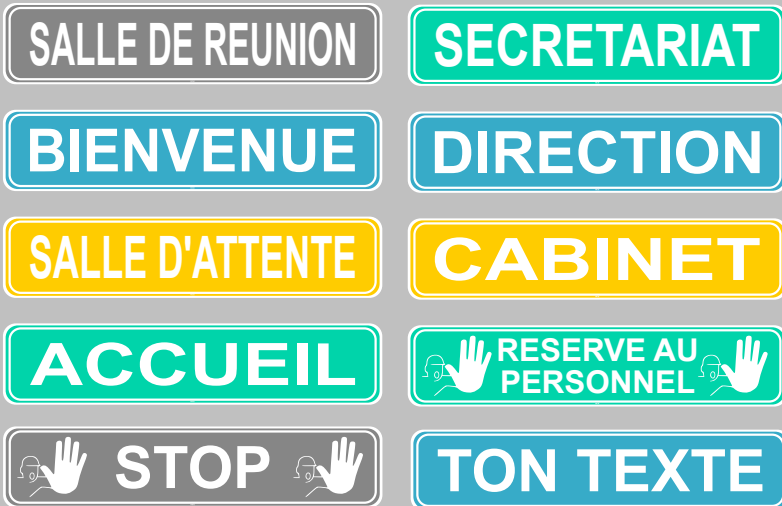

Rectangle de 70/15 cm

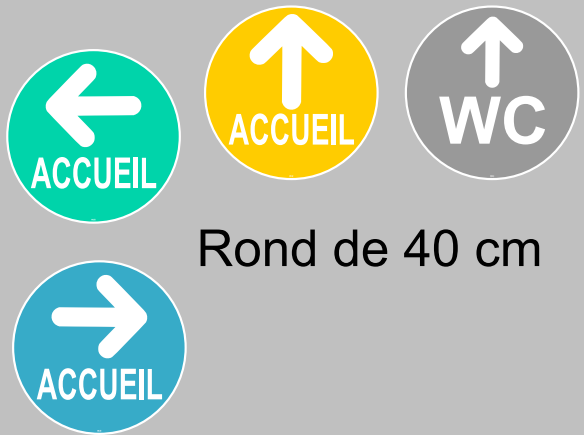

Rond de 40 cm

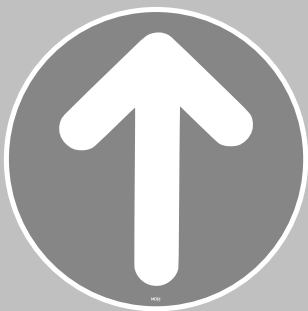

Rond de 30 cm



Autres motifs sur demande





# Je dirige mes visiteurs

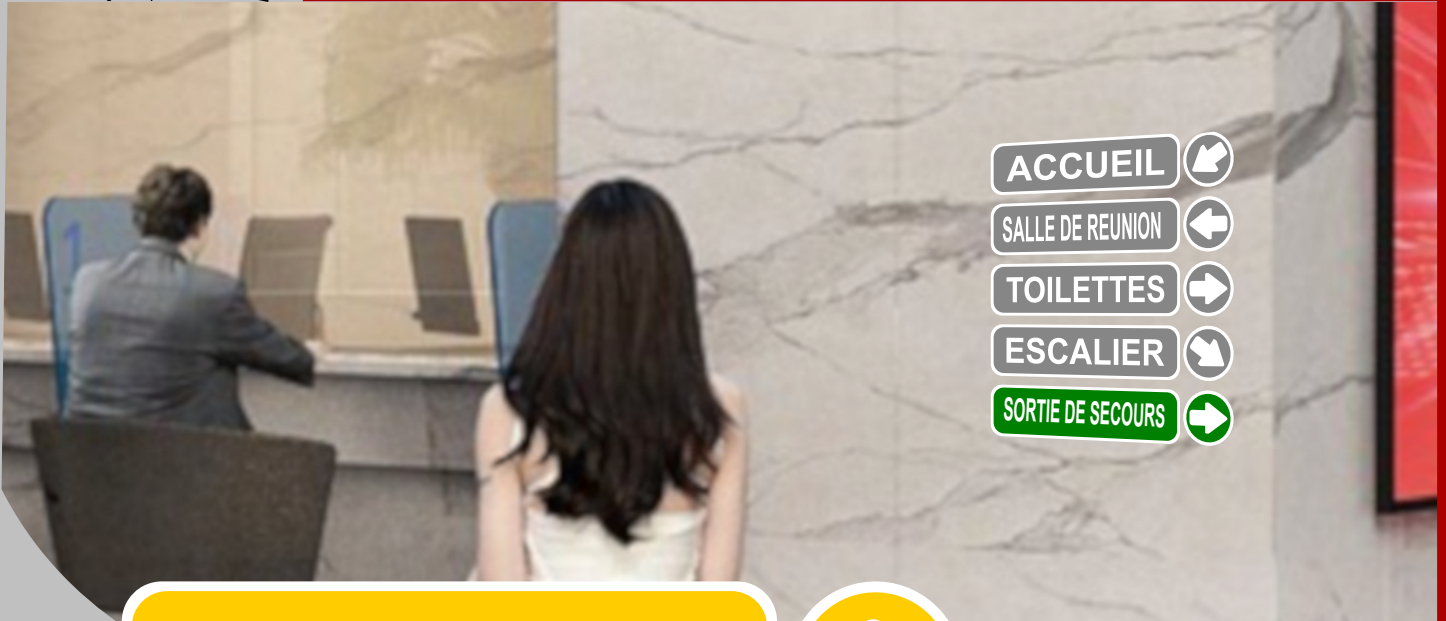

- ACCUEIL 
- SALLE DE REUNION 
- TOILETTES 
- ESCALIER 
- SORTIE DE SECOURS 





## ACCUEIL

- SALLE DE REUNION 
- TOILETTES 
- ESCALIER 
- SORTIE DE SECOURS 
- DIRECTION 
- ACHAT 

**700--** -signalisation de direction  
adhésif 30/8 cm + flèche 8 cm

-Interieur et exterior  
-11 couleurs au choix  
-Votre texte 25/4 cm

autocollant adhésif permettant de faire une signalétique de direction efficace et esthétique dans tous vos locaux. Sa flèche indépendante ronde vous permet de choisir la direction voulu, à gauche, droite, haut, bas même à 45°.

-  **BUREAU**
-  **SANS ISSUE**
- RENSEIGNEMENT** 
- ATELIER** 



### Les plaques de portes

Des centaines de plaques en standard



Plaque de porte intérieure PVC 18/5 cm et 2 mm d'épaisseur  
Autoadhésive pour une rapidité et facilité de pose  
Fond effet ALU ou BOIS au choix  
Pictogramme pour une meilleur compréhension  
Possibilités de personnalisation

### Les pictogrammes

**701--** -Pictogramme adhésif 15/15 cm  
-Interieur et exterior  
-11 couleurs au choix  
-Pictogramme au choix



autocollant adhésif permettant de faire une signalétique simple, efficace et esthétique dans tous vos locaux. Des milliers de pictogrammes possible avec ou sans texte.

4 couleurs tendances pour les bureaux



7 couleurs signalétique industrie, atelier ...



[www.mdh-pochoirs.fr](http://www.mdh-pochoirs.fr)

**Fabriqu** en **France**



Je dirige mes visiteurs



# Un parking bien marqué

## Les Pochoirs

Définir les places de parking permet de ranger plus de voitures

### Le traçage du parking

Les lignes

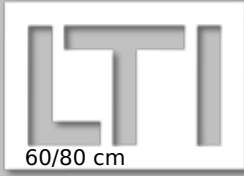
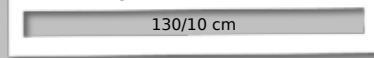

60/80 cm

Simple et économique toutes vos places de parking tracées avec 1 pochoir



50/50 cm

Pour marquer un cédez de passage



120/50 cm

Pour marquer un stop

3 pochoirs pour 6 réalisations

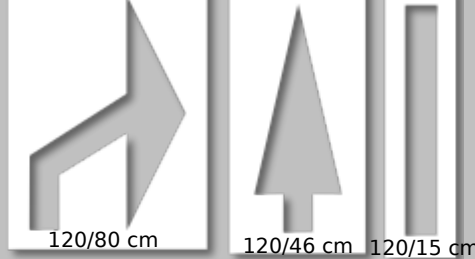

120/80 cm

120/46 cm

120/15 cm

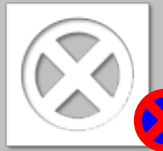
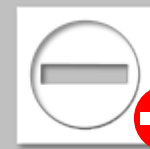
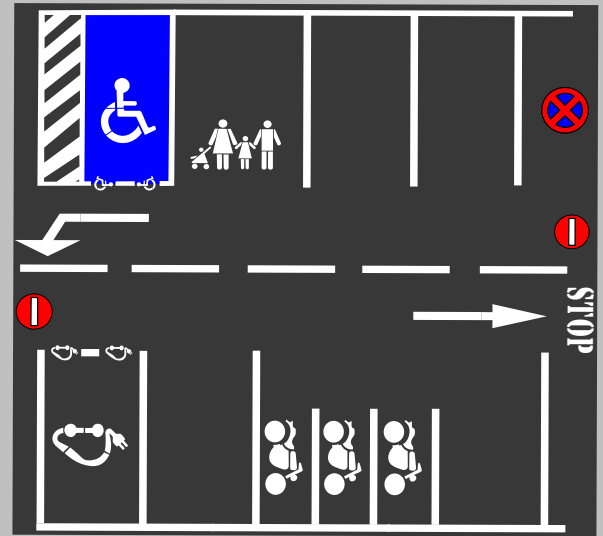
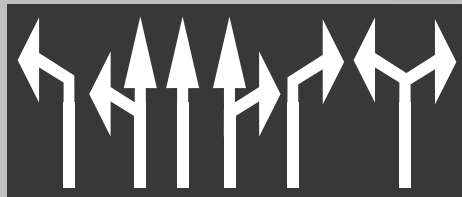

### Les places réservées



texte personnalisé 1M30  
hauteur 15, 20 ou 30 cm



### Les limitations de vitesses

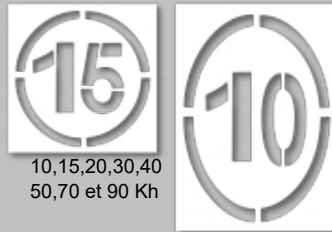

10, 15, 20, 30, 40  
50, 70 et 90 Kh



### Le cheminement piéton

Pochoir ALU avec cadre bois pliable pour un passage piéton réussi et rapide

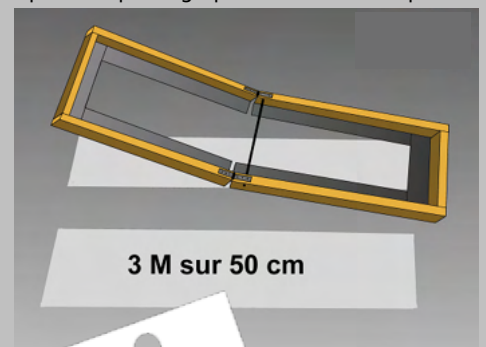

3 M sur 50 cm



Piéton  
60/35 ou 120/70 cm

Des milliers de motifs disponibles alors faite votre demande

Personnalisation sur mesure (logo, texte, pictogramme ...)





# Un entrepôt bien repéré

## Les Pochoirs

INDIQUER UNE BONNE CIRCULATION  
ELIMINE UNE GRANDE PARTIE DES ACCIDENTS

### Les cheminements



### Les directions

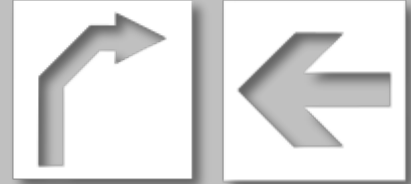

Interdire

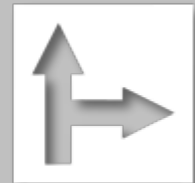

### Les EPI



### La sécurité

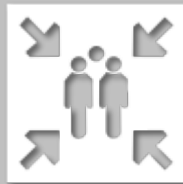

### Les zébras

20,30,40,80 cm  
de largeur

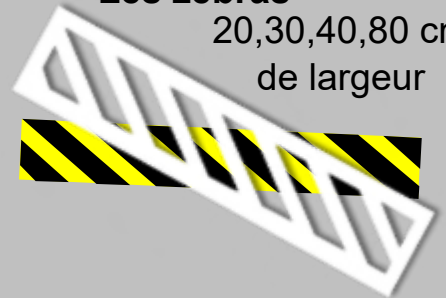

## Les Adhésifs au sol

### Adhésifs en rouleaux

Forme découpée de couleur  
pour un repérage rapide  
sans interruption de production

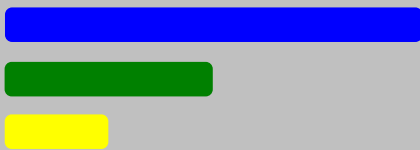



# Un entrepôt bien signalé

Adhésif de longue tenue avec lamination antidérapante R9 de grande qualité

## Les adhésifs 60/40 cm



## Les panneaux adhésifs au sol



Rond adhésif au sol de 40 cm  
Triangle adhésif au sol de 40/35 cm





# Un entrepôt bien signalé

## Le passage piéton

**683** Bande simple

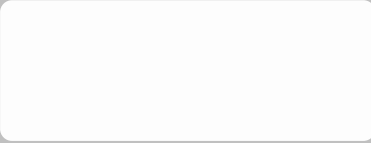

Bande de 80/30 cm  
coins arrondis

**684** Avec panneaux attention piéton



**685** Avec panneau attention regard gauche & droite

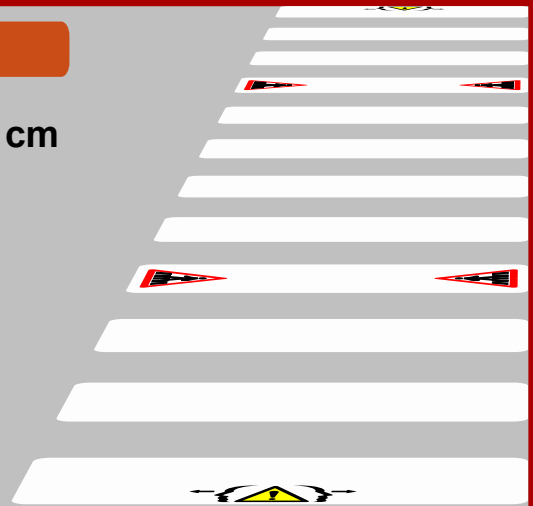

## Le marquage dans les stocks

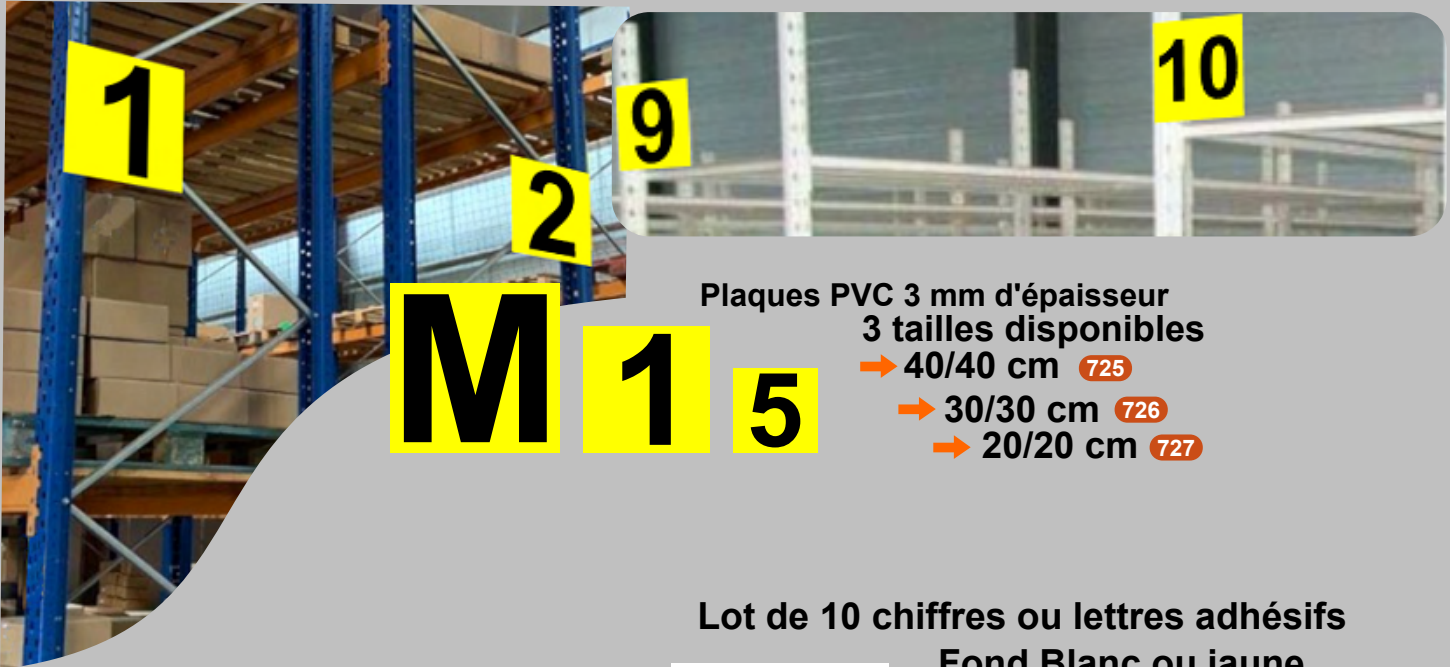

Plaques PVC 3 mm d'épaisseur  
3 tailles disponibles  
→ 40/40 cm **725**  
→ 30/30 cm **726**  
→ 20/20 cm **727**

Lot de 10 chiffres ou lettres adhésifs  
Fond Blanc ou jaune  
20, 30, 50, 80 ou 120 mm

Panneau d'indications  
de charges 30/40 cm **729**

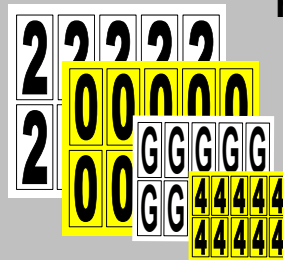
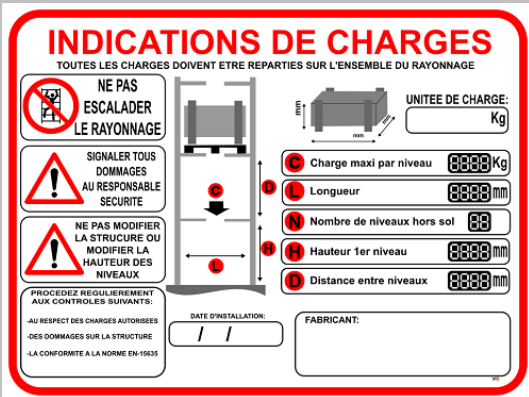

Un entrepôt bien signalé



www.mdh-pochoir.fr

Fabriqué en France



# Je trie mes déchets

La bonne poubelle pour le bon déchet



Adhésifs de 20/20 cm  
intérieur / extérieur

Utilisable sur les poubelles, les murs, les conteneurs et bien d'autres

Les pochoirs pour un marquage bien visible

Pour éviter les déversements  
dans les bouches d'égouts

NE RIEN JETER  
~ L'OCEAN ~  
COMMENCE ICI



Je note  
au marqueur.

Votre distributeur:



Fabriqué en France

Par: mdh-pochoir.fr

Je trie mes déchets